



# KOHLHAUER® NOISE BARRIERS – QUALITY OF LIFE

## **KOHLHAUER SCORSA® FRAME - THE TRANSPARENT SOLUTION**

Austria · Bosnia & Herzegovina · Bulgaria · China · Czech Republic · France · Germany · Greece · Hong Kong · Italy · Korea · Latvia · Netherlands · Poland · Romania · Serbia · Spain · Sweden · Switzerland · Turkey · United Kingdom

### **BEST VIEW** <

- Marketable standard sizes
- Various pane material
- Individual design options

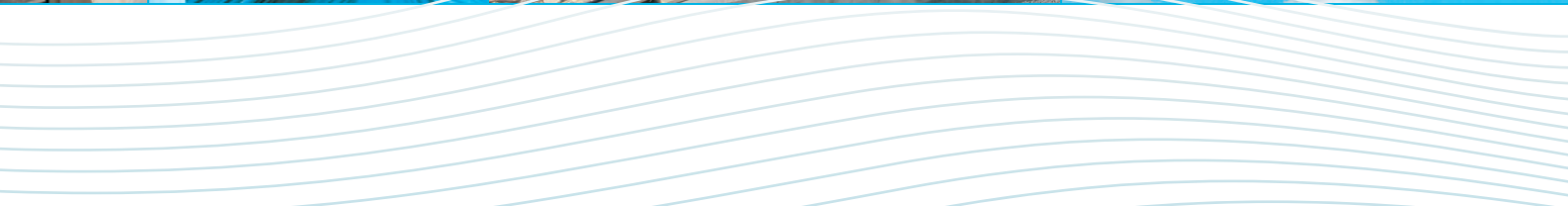

# KOHLHAUER **SCORSA**<sup>®</sup> **FRAME** - UTMOST FUNCTIONALITY FOR **TRANSPARENT NOISE PROTECTION BY STANDARD FORMAT**

KOHLHAUER **SCORSA**<sup>®</sup> **FRAME** - noise barriers are renowned for their innovative, durable and economic noise solutions and captivation design - Functional walls with the best views. The sophisticated element design and advanced system components allow for an extremely easy assembly of the noise barriers. KOHLHAUER **SCORSA**<sup>®</sup> **FRAME**, the reasonable solution for any budget.

KOHLHAUER **SCORSA**<sup>®</sup> **FRAME** noise barriers perfectly combine attractive appearance, simple assembly with superior technical achievement. They allow a panoramic view of the surrounding landscape and help to prevent the well known problem of "tunnel vision". In this way they help to improve quality of life as well as increase road traffic safety.

## Benefits

- Noise barrier without blocked views
- Stable frame profil made of coated aluminium
- Modular standard components for a cost-efficient realisation of small, medium and large-scale projects
- Available with various pane materials
- Also available with tempered surface
- Optional bird protection stripes
- Extensive colour range for individual design
- CE conformity are present

## Product specifications

- Excellent sound-insulating performance
- Stable element structure – also for high loads
- Extremely high aging and corrosion resistance
- High UV and colour resistance of all used materials
- All used materials 100% recyclable
- Pane infill made of acrylic, silicate glass as well as polycarbonate
- Increased sound protection and sound absorption, when combined with other KOHLHAUER<sup>®</sup> noise barrier elements

### Classification of the acoustic characteristics accord. to EN ISO 717-1 as well as EN 1793

<b>SCORSA FRAME</b> (sheet material)	<b>Thickness</b>	<b>R<sub>w</sub> (C;C)<sub>tr</sub></b>	<b>Sound insulation</b> <b>DL<sub>r</sub></b>	<b>Group</b>
<b>Polycarbonate</b>	8 mm	<b>29 (-1;-2) dB</b>	<b>27 dB</b>	<b>B3</b>
	15 mm	<b>33 (-1;-2) dB</b>	<b>31 dB</b>	<b>B3</b>
<b>Single-pane safety glass</b>	12 mm	<b>30 (-1;-1) dB</b>	<b>29 dB</b>	<b>B3</b>
<b>Acrylic glass</b>	15 mm	<b>33 (-1;-2) dB</b>	<b>30 dB</b>	<b>B3</b>
	20 mm	<b>33 (-2;-2) dB</b>	<b>31 dB</b>	<b>B3</b>

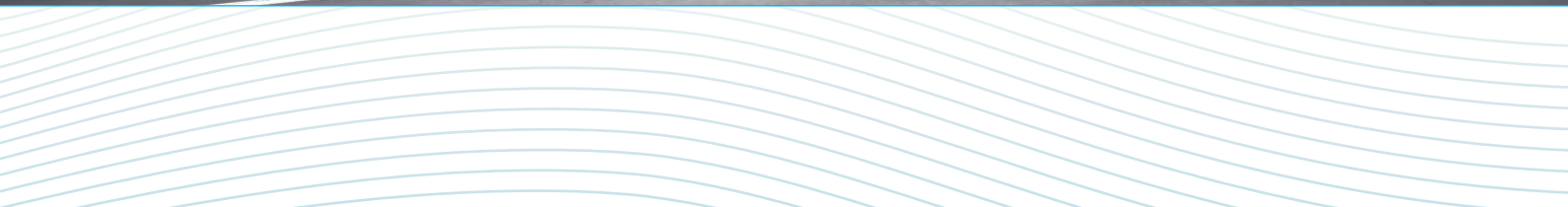
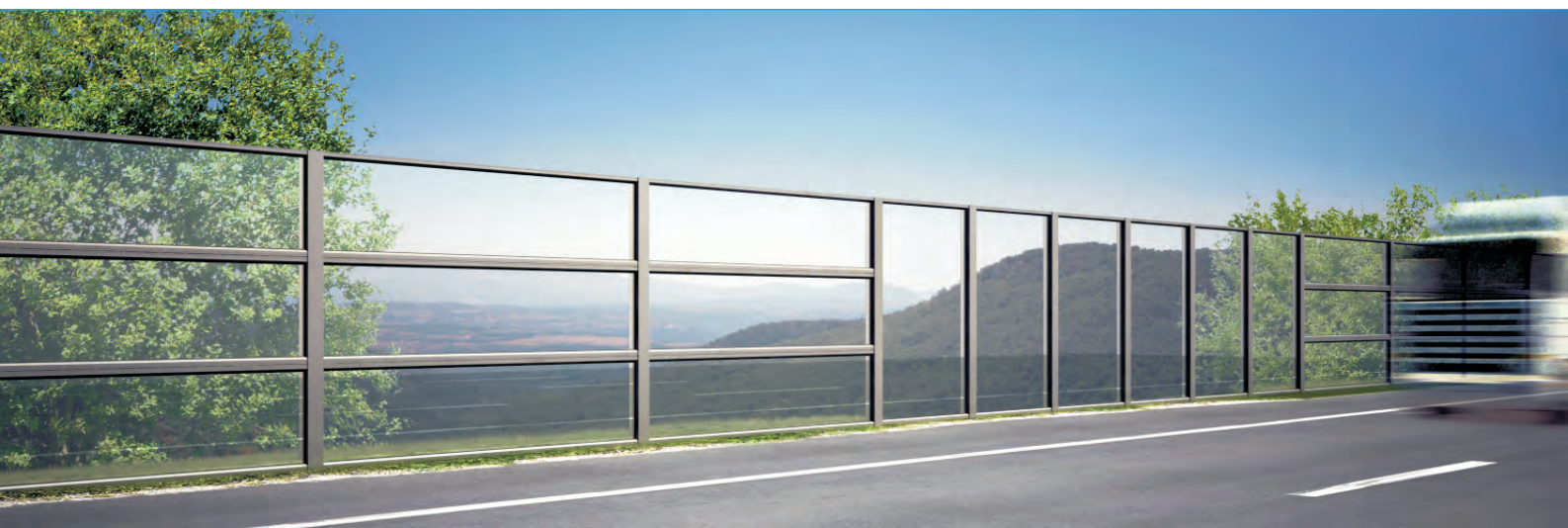

## TECHNICAL SPECIFICATIONS

- KOHLHAUER **SCORSA® FRAME** is designed for the highest standard supplementary technical regulation, the German ZTV-LSW 06
- Noise insulation values depend on thickness of panes and materials according to DIN EN 1793-2; e.g.  $R_w \geq 30$  dB,  $DL_R \geq 29$  dB
- Wind load 1,0 kN/m<sup>2</sup> and more
- Fire resistance class 1-3 pursuant to DIN EN 1794-2, Appendix A
- Load bending tested pursuant to DIN EN 1794-1, Appendix 4

## BASIC ELEMENTS

### Standard equipment for road

Element dimension 3960 x 1000 mm, aluminium frame 70/63, coated with RAL 9006, pane material: Acrylic sheets (PMMA), Polycarbonate (PC) or single-pane security glass, regarding sound insulation requirements and local legislations, incl. 4 clamping bolts for pillar-mounting.

### Standard equipment for bridges<sup>1)</sup>

Element dimension 1960 x 3000 mm, aluminium frame 70/63, coated with RAL 9006, pane material: Acrylic sheets (PMMA) or Polycarbonate (PC) (regarding local legislations), incl. 8 clamp bolts for pillar mounting and sealing rubber (if required)

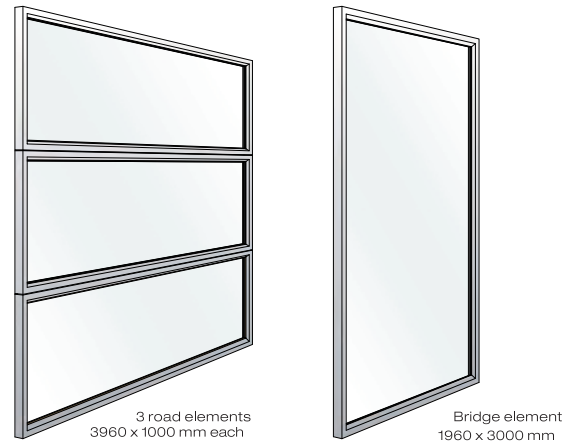

## ADVANCED ELEMENTS

- **Transit profil** (3960 x 113 mm) for installation on a KOHLHAUER **PLANTA®** element
- **Bird protection** applied with screen printing, horizontal, 2/30/2 mm
- Security rope, including sheet drillings
- Special formats (e.g. parallelogram)
- Compensation for different post distances
- **Easy-to-clean-coating** to facilitate removing graffiti from the panes
- Selected **RAL-Colours** for a high-quality noise barrier finish (see colour chart)
- Colour options for transparent panes are available on request

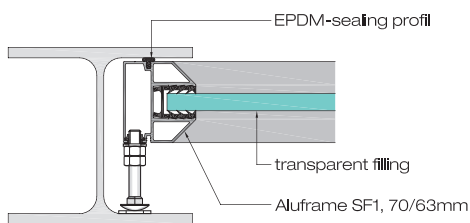

KOHLHAUER SCORSA® SF1

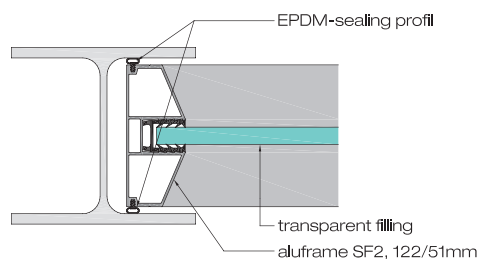

KOHLHAUER SCORSA® SF2

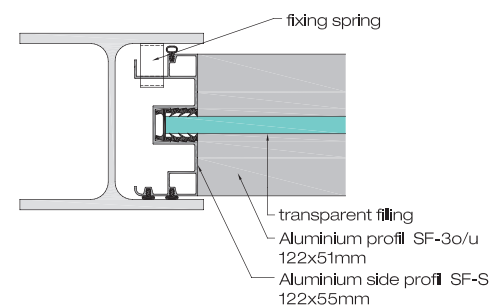

KOHLHAUER SCORSA® SF3

<sup>1)</sup> Application in fall-risk areas only permitted with additional guard equipment according to respective regulations





**R. Kohlhauer GmbH**  
Draisstraße 2  
76571 Gaggenau | Germany  
Phone: 0049 72 25 97 57-0  
Fax: 0049 72 25 97 57-26  
E-Mail: info@kohlhauer.com

[WWW.KOHLHAUER.COM](http://WWW.KOHLHAUER.COM)



**GreeNestForm AB**  
Verkstadsgatan 11  
599 21 Ödeshög | Sweden  
Phone: 0046 144 31409  
Fax: 0046 144 31429  
E-Mail: info@gnf.eu

[WWW.GNF.EU](http://WWW.GNF.EU)

## MORE KOHLHAUER® PRODUCTS



The reasonable and proven all-round Grid-Insulation-System (GIS) with many design variations.



The plantable noise barrier - eco-friendly, sustainable and high functional.



Double benefit: Noise barrier combined with sustainable power generation through solar technology.

